

WARNING

PLEASE READ ALL INSTRUCTIONS BEFORE ATTEMPTING INSTALLATION

- To prevent personal injury or product damage only licensed electricians should install.
- To avoid electric shock or component damage disconnect power before attempting installation or servicing.
- This product must be installed in accordance with the national electric code (NEC) and all applicable federal, state and local electric codes and safety standards.
- Disconnect product and allow cooling prior to servicing.
- Any alteration or modification of this product is expressly forbidden as it may cause serious personal injury, death, property damage and/or product malfunction.
- To prevent product malfunction and/or electrical shock this product must be properly grounded.
- This luminaire is designed to operate in ambient temperatures ranging from -40°C to 45°C.
- This product must be installed in accordance with the applicable installation code by a Person familiar with the construction and operation of the product and the hazards involved.
- In 75°C supply conductors.

Installation Guide

Slipfitter

1. Make wiring connection before fixing the slip fitter onto the pipe.
2. Remove the side plate from slipfitter.
3. Loosen center bolt, rotate the rail part to desired angle and tighten center bolt.
4. Route the cord into slipfitter through the hole for wiring, slide the fixture onto the slipfitter and tighten bottom screws.
5. Make wiring connection, replace the side plate and tighten screws.

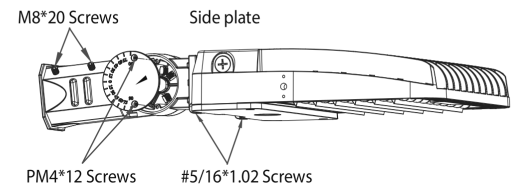

(Figure 1)

Wall Mount

1. Remove the side plate by loosen the screws.
2. Fix the back plate onto the arm bracket with screws provided.
3. Use the metal template provided to locate footprint on the wall to drill the holes, then fix the bracket on the wall with screws.
4. Route the power cord into wall mount bracket, slide the fixture onto the mounting bracket, then tighten bottom screws.
5. Make wiring connection inside of bracket and replace the side plate with screws.

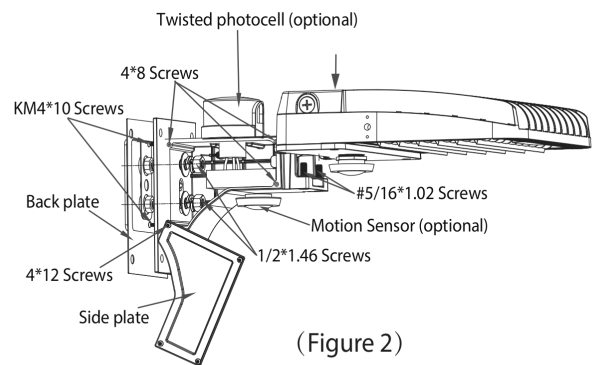

(Figure 2)

Trunnion/Yoke

1. Mount fixture onto surface using the hole pattern provided on the trunnion bracket.
2. Loosen center bolts and set screw.
3. Rotate fixture to desired aiming position and tighten center bolts.
4. Make wiring connection as per wire diagram below.

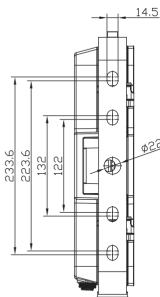

(Trunnion)

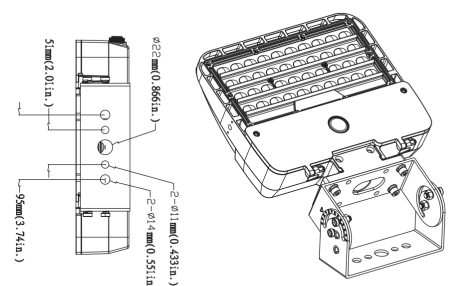
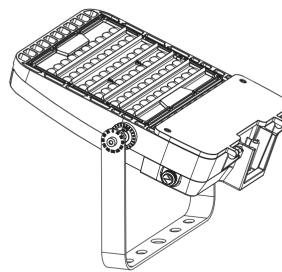

(Yoke 70W-200W)

PHOTOCELL INSTALLATION

Universal voltage driver permits operation at 120V to 277VAC, 60 Hz except fixtures factory ordered with a 347V photocell (P3) or 480V photocell (P4) or 120-277V photocell(P0).

1. Install photocell and wire as per diagram.
2. Use photocell rated for your supply voltage.

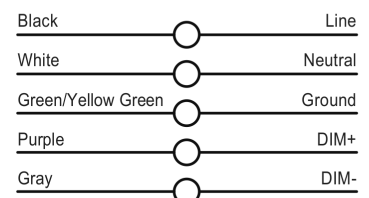
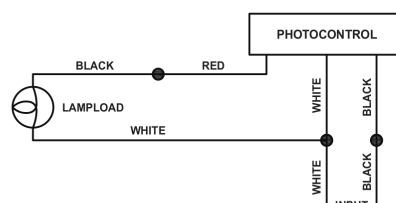

TROUBLESHOOTING

1. Check that the line voltage at the fixture is correct. Refer to wiring directions.
2. Is the fixture grounded properly.
3. Be sure the photocell, if used, is functioning properly.